

M12 D code male moldable connector, unshielded/M12, D型公头成型式连接器, 不带屏蔽

Illustration/尺寸

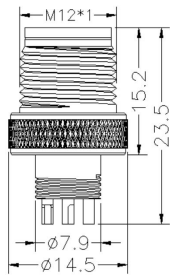

Product photo/产品图



Part number/产品料号

Pins/针数	Code/型	Part number/产品料号
4pins/4针	D code/D型	12C139

Pin assignment front view/针位分布前视图

D code 4pins
D型4针



General data/常规数据

Pins Numbers/针数	4pins/4针
Rated voltage/额定电压	250V
Rated current(40°C)/额定电流	4A
Standards/标准	IEC 61076-2-101
Termination/焊接方式	solder/焊接
Degree of protection/防护等级	IP67, IP68, IP69K
Wire gauge(mm²)/线规(平方数)	0.14mm²-0.75mm²
Wire gauge(AWG)/线号(平方数)	26AWG-18AWG
Mechanical operation/插拔次数	>100 mating cycles/大于100次
Ambient temperature (operation)/操作温度	-25°C~+85°C
Contact resistance/接触电阻	≤5mΩ
Insulation resistance/绝缘电阻	≥100MΩ
Connector body/胶芯	TPU
Pins/端子	Brass with gold plated/黄铜镀金
Screw/螺丝	Brass with nickel plated/黄铜镀镍
Environmental compliance/环境符合标准	RoHs, Reach

M12 D code female moldable connector, unshielded/M12, D型母头成型式连接器, 不带屏蔽

Illustration/尺寸

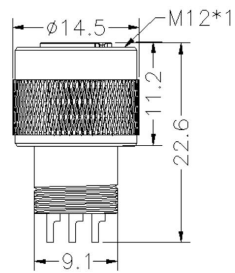

Product photo/产品图



Part number/产品料号

Pins/孔数	Code/型	Part number/产品料号
4pins/4孔	D code/D型	12C140

Pin assignment front view/孔位分布前视图

D code 4pins
D型4孔



General data/常规数据

Pins Numbers/孔数	4pins/4孔
Rated voltage/额定电压	250V
Rated current(40°C)/额定电流	4A
Standards/标准	IEC 61076-2-101
Termination/焊接方式	solder/焊接
Degree of protection/防护等级	IP67, IP68, IP69K
Wire gauge(mm²)/线规(平方数)	0.14mm²-0.75mm²
Wire gauge(AWG)/线号(平方数)	26AWG-18AWG
Mechanical operation/插拔次数	>100 mating cycles/大于100次
Ambient temperature (operation)/操作温度	-25°C~+85°C
Contact resistance/接触电阻	≤5mΩ
Insulation resistance/绝缘电阻	≥100MΩ
Connector body/胶芯	TPU
Pins/端子	Phosphorus copper with gold plated/磷铜镀金
Screw/螺丝	Brass with nickel plated/黄铜镀镍
Gasket/胶圈	Fluorine ring/氟胶圈
Environmental compliance/环境符合标准	RoHs, Reach

M12 D code male moldable connector with shielded/M12, D型公头成型式连接器, 带屏蔽

Illustration/尺寸

Product photo/产品图

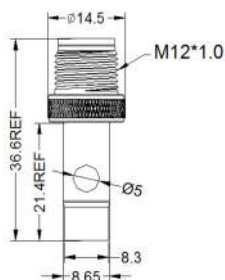

Part number/产品料号

Pins/针数	Code/型	Part number/产品料号
4pins/4针	D code/D型	12C127

Pin assignment front view/针位分布前视图

D code 4pins
D型4针



General data/常规数据

Pins Numbers/针数	4pins/4针
Rated voltage/额定电压	250V
Rated current(40°C)/额定电流	4A
Standards/标准	IEC 61076-2-101
Termination/焊接方式	solder/焊接
Degree of protection/防护等级	IP67, IP68, IP69K
Wire gauge(mm²)/线规(平方数)	0.14mm²-0.75mm²
Wire gauge(AWG)/线号(平方数)	26AWG-18AWG
Mechanical operation/插拔次数	>100 mating cycles/大于100次
Ambient temperature (operation)/操作温度	-25°C~+85°C
Contact resistance/接触电阻	≤5mΩ
Insulation resistance/绝缘电阻	≥100MΩ
Connector body/胶芯	TPU
Pins/端子	Brass with gold plated/黄铜镀金
Screw/螺丝	Brass with nickel plated/黄铜镀镍
Environmental compliance/环境符合标准	RoHs, Reach

M12 D code female moldable connector with shielded/M12, D型母头成型式连接器, 带屏蔽

Illustration/尺寸

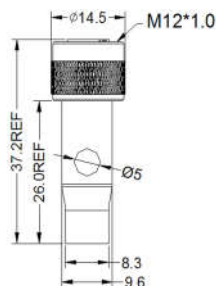

Product photo/产品图



Part number/产品料号

Pins/孔数	Code/型	Part number/产品料号
4pins/4孔	D code/D型	12C144

Pin assignment front view/孔位分布前视图

D code 4pins
D型4孔

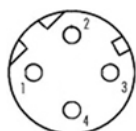

General data/常规数据

Pins Numbers/孔数	4pins/4孔
Rated voltage/额定电压	250V
Rated current(40°C)/额定电流	4A
Standards/标准	IEC 61076-2-101
Termination/焊接方式	solder/焊接
Degree of protection/防护等级	IP67, IP68, IP69K
Wire gauge(mm²)/线规(平方数)	0.14mm²-0.75mm²
Wire gauge(AWG)/线号(平方数)	26AWG-18AWG
Mechanical operation/插拔次数	>100 mating cycles/大于100次
Ambient temperature (operation)/操作温度	-25°C~+85°C
Contact resistance/接触电阻	≤5mΩ
Insulation resistance/绝缘电阻	≥100MΩ
Connector body/胶芯	TPU
Pins/端子	Phosphorus copper with gold plated/磷铜镀金
Screw/螺丝	Brass with nickel plated/黄铜镀镍
Gasket/胶圈	Fluorine ring/氟胶圈
Environmental compliance/环境符合标准	RoHs, Reach

M12 D code male straight front panel mount connector, unshielded, insert/M12, D型公头直头前锁面板板端, 不带屏蔽

Illustration/尺寸

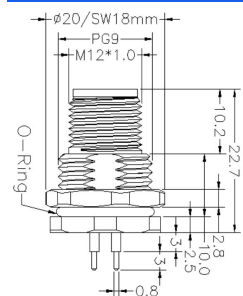

Product photo/产品图



Part number/产品料号

Pins/针数	Code/型	Part number/产品料号	
		PG9 thread 15.3±0.1/PG9螺纹15.3±0.1	M16 thread 16±0.1/M16螺纹16±0.1
4pins/4针	D code/D型	12B049	12B053

Pin assignment front view/针位分布前视图

D code 4pins

D型4针



General data/常规数据

Pins Numbers/针数	4pins/4针
Rated voltage/额定电压	250V
Rated current(40°C)/额定电流	4A
Standards/标准	IEC 61076-2-101
Termination/焊接方式	solder PCB/PCB焊接
Connector locking system/锁紧方式	Screw/螺锁
Degree of protection/防护等级	IP67, IP68, IP69K
Mechanical operation/插拔次数	>100 mating cycles/大于100次
Ambient temperature (operation)/操作温度	-25°C~+85°C
Contact resistance/接触电阻	≤5mΩ
Insulation resistance/绝缘电阻	≥100MΩ
Connector body/胶芯	TPU
Pins/端子	Brass with gold plated/黄铜镀金
Screw/螺丝	Brass with nickel plated/黄铜镀镍
Gasket/胶圈	Fluorine ring/氟胶圈
Environmental compliance/环境符合标准	RoHs, Reach

M12 D code female straight front panel mount connector, unshielded, insert/M12, D型母头直头前锁面板板端, 不带屏蔽

Illustration/尺寸

Product photo/产品图

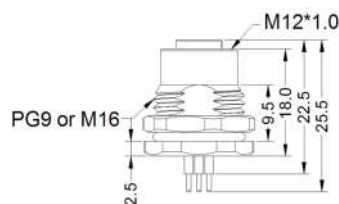

Part number/产品料号

Pins/孔数	Code/型	Part number/产品料号	
		PG9 thread 15.3±0.1/PG9螺纹15.3±0.1	M16 thread 16±0.1/M16螺纹16±0.1
4pins/4孔	D code/D型	12B051	12B055

Pin assignment front view/孔位分布前视图

D code 4pins
D型4孔

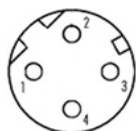

General data/常规数据

Pins Numbers/孔数	4pins/4孔
Rated voltage/额定电压	250V
Rated current(40°C)/额定电流	4A
Standards/标准	IEC 61076-2-101
Termination/焊接方式	solder PCB/PCB焊接
Connector locking system/锁紧方式	Screw/螺锁
Degree of protection/防护等级	IP67, IP68, IP69K
Mechanical operation/插拔次数	>100 mating cycles/大于100次
Ambient temperature (operation)/操作温度	-25°C~+85°C
Contact resistance/接触电阻	≤5mΩ
Insulation resistance/绝缘电阻	≥100MΩ
Connector body material/胶芯材料	TPU
Pins material/端子材料	Phosphorus copper with gold plated/磷铜镀金
Screw/螺丝材料	Brass with nickel plated/黄铜镀镍
Gasket material/胶圈材料	Fluorine ring/氟胶圈
Environmental compliance/环境符合标准	RoHs, Reach

M12 D code male straight rear panel mount connector, unshielded, insert/M12, D型公头直头后锁面板板端, 不带屏蔽

Illustration/尺寸

Product photo/产品图

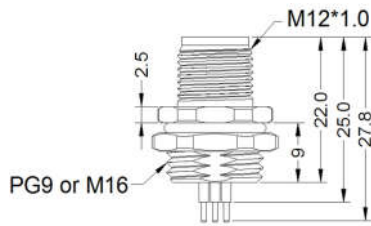

Part number/产品料号

Pins/针数	Code/型	Part number/产品料号	
		PG9 thread 15.3±0.1/PG9螺纹15.3±0.1	M16 thread 16±0.1/M16螺纹16±0.1
4pins/4针	D code/D型	12B050	12B054

Pin assignment front view/针位分布前视图

D code 4pins
D型4针



General data/常规数据

Pins Numbers/针数	4pins/4针
Rated voltage/额定电压	250V
Rated current(40°C)/额定电流	4A
Standards/标准	IEC 61076-2-101
Termination/焊接方式	solder PCB/PCB焊接
Connector locking system/锁紧方式	Screw/螺锁
Degree of protection/防护等级	IP67, IP68, IP69K
Mechanical operation/插拔次数	>100 mating cycles/大于100次
Ambient temperature (operation)/操作温度	-25°C~+85°C
Contact resistance/接触电阻	≤5mΩ
Insulation resistance/绝缘电阻	≥100MΩ
Connector body/胶芯	TPU
Pins/端子	Brass with gold plated/黄铜镀金
Screw/螺丝材料	Brass with nickel plated/黄铜镀镍
Gasket/胶圈	Fluorine ring/氟胶圈
Environmental compliance/环境符合标准	RoHs, Reach

M12 D code female straight rear panel mount connector, unshielded, insert/M12, D型母头直头后锁面板板端, 不带屏蔽

Illustration/尺寸

Product photo/产品图

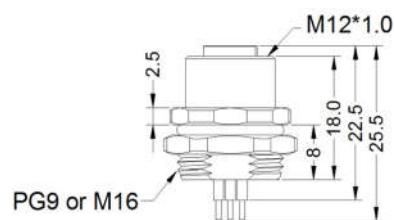

Part number/产品料号

Pins/孔数	Code/型	Part number/产品料号	
		PG9 thread 15.3±0.1/PG9螺纹15.3±0.1	M16 thread 16±0.1/M16螺纹16±0.1
4pins/4孔	D code/D型	12B052	12B056

Pin assignment front view/孔位分布前视图

D code 4pins
D型4孔

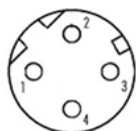

General data/常规数据

Pins Numbers/孔数	4pins/4孔
Rated voltage/额定电压	250V
Rated current(40°C)/额定电流	4A
Standards/标准	IEC 61076-2-101
Termination/焊接方式	solder PCB/PCB焊接
Connector locking system/锁紧方式	Screw/螺锁
Degree of protection/防护等级	IP67, IP68, IP69K
Mechanical operation/插拔次数	>100 mating cycles/大于100次
Ambient temperature (operation)/操作温度	-25°C~+85°C
Contact resistance/接触电阻	≤5mΩ
Insulation resistance/绝缘电阻	≥100MΩ
Connector body/胶芯	TPU
Pins/端子	Phosphorus copper with gold plated/磷铜镀金
Screw/螺丝	Brass with nickel plated/黄铜镀镍
Gasket/胶圈	Fluorine ring/氟胶圈
Environmental compliance/环境符合标准	RoHS, Reach

M12 D code male right angle front panel mount connector, unshielded, insert/M12, D型公头弯头前锁面板板端, 不带屏蔽

Illustration/尺寸

Product photo/产品图

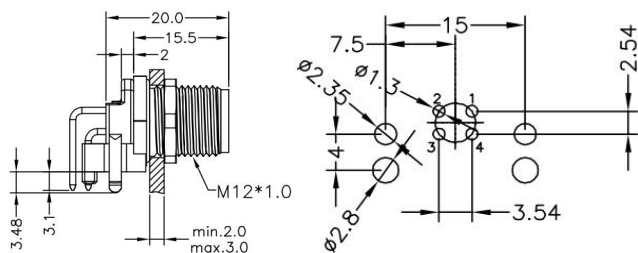

Part number/产品料号

Pins/针数	Code/型	Part number/产品料号
4pins/4针	D code/D型	12B114

Pin assignment front view/针位分布前视图

D code 4pins
D型4针



General data/常规数据

Pins Numbers/针数	4pins/4针
Rated voltage/额定电压	250V
Rated current(40°C)/额定电流	4A
Standards/标准	IEC 61076-2-101
Termination/焊接方式	solder PCB/PCB焊接
Connector locking system/锁紧方式	Screw/螺锁
Degree of protection/防护等级	IP67, IP68, IP69K
Mechanical operation/插拔次数	>100 mating cycles/大于100次
Ambient temperature (operation)/操作温度	-25°C~+85°C
Contact resistance/接触电阻	≤5mΩ
Insulation resistance/绝缘电阻	≥100MΩ
Connector body/胶芯	TPU
Pins/端子	Brass with gold plated/黄铜镀金
Screw/螺丝	Brass with nickel plated/黄铜镀镍
Gasket/胶圈	Fluorine ring/氟胶圈
Environmental compliance/环境符合标准	RoHs, Reach

M12 D code female right angle front panel mount connector, unshielded, insert/M12, D型母头弯头前锁面板板端, 不带屏蔽

Illustration/尺寸

Product photo/产品图

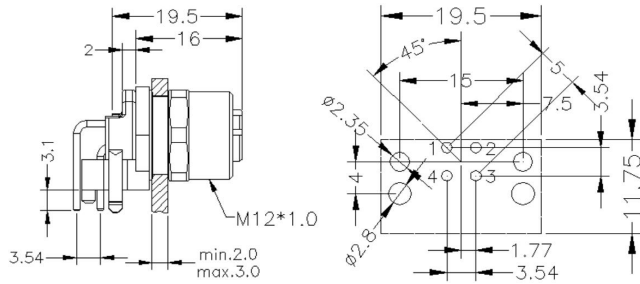

Part number/产品料号

Pins/孔数	Code/型	Part number/产品料号
4pins/4孔	D code/D型	12B115

Pin assignment front view/孔位分布前视图

D code 4pins
D型4孔



General data/常规数据

Pins Numbers/孔数	4pins/4孔
Rated voltage/额定电压	250V
Rated current(40°C)/额定电流	4A
Standards/标准	IEC 61076-2-101
Termination/焊接方式	solder PCB/PCB焊接
Connector locking system/锁紧方式	Screw/螺锁
Degree of protection/防护等级	IP67, IP68, IP69K
Mechanical operation/插拔次数	>100 mating cycles/大于100次
Ambient temperature (operation)/操作温度	-25°C~+85°C
Contact resistance/接触电阻	≤5mΩ
Insulation resistance/绝缘电阻	≥100MΩ
Connector body/胶芯	TPU
Pins/端子	Phosphorus copper with gold plated/磷铜镀金
Screw/螺丝	Brass with nickel plated/黄铜镀镍
Gasket/胶圈	Fluorine ring/氟胶圈
Environmental compliance/环境符合标准	RoHs, Reach

M12 D code male straight front panel mount connector, unshielded, solder/M12,D型公头直头前锁面板焊线式, 不带屏蔽

Illustration/尺寸

Product photo/产品图

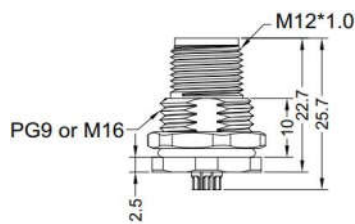

Part number/产品料号

Pins/针数	Code/型	Part number("X" is length millimetre mm)/产品料号("X"表示长度, 单位毫米mm)	
4pins/4针	D code/D型	PG9 thread 15.3±0.1/PG9螺纹15.3±0.1	M16 thread 16±0.1/M16螺纹16±0.1
		12H049-X	12H053-X

Pin assignment front view/针位分布前视图

D code 4pins
D型4针



General data/常规数据

Pins Numbers/针数	4pins/4针
Rated voltage/额定电压	250V
Rated current(40°C)/额定电流	4A
Standards/标准	IEC 61076-2-101
Termination/焊接方式	solder/焊接
Connector locking system/锁紧方式	Screw/螺锁
Degree of protection/防护等级	IP67, IP68, IP69K
Wire gauge(mm²)/线规(平方数)	0.14mm²-0.75mm²
Wire gauge(AWG)/线号(平方数)	26AWG-18AWG
Mechanical operation/插拔次数	>100 mating cycles/大于100次
Ambient temperature (operation)/操作温度	-40°C~+85°C
Contact resistance/接触电阻	≤5mΩ
Insulation resistance/绝缘电阻	≥100MΩ
Connector body/胶芯	TPU
Pins/端子	Brass with gold plated/黄铜镀金
Screw/螺丝	Brass with nickel plated/黄铜镀镍
Gasket/胶圈	Fluorine ring/氟胶圈
Environmental compliance/环境符合标准	RoHs, Reach

M12 D code female straight front panel mount connector, unshielded, solder/M12,D型母头直头前锁面板焊线式, 不带屏蔽

Illustration/尺寸

Product photo/产品图

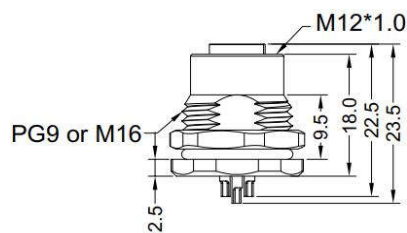

Part number/产品料号

Pins/孔数	Code/型	Part number("X" is length millimetre mm)/产品料号("X"表示长度, 单位毫米mm)	
		PG9 thread 15.3±0.1/PG9螺纹15.3±0.1	M16 thread 16±0.1/M16螺纹16±0.1
4pins/4孔	D code/D型	12H051-X	12H055-X

Pin assignment front view/孔位分布前视图

D code 4pins
D型4孔

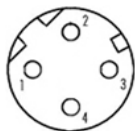

General data/常规数据

Pins Numbers/孔数	4pins/4孔
Rated voltage/额定电压	250V
Rated current(40°C)/额定电流	4A
Standards/标准	IEC 61076-2-101
Termination/焊接方式	solder/焊接
Connector locking system/锁紧方式	Screw/螺锁
Degree of protection/防护等级	IP67, IP68, IP69K
Wire gauge(mm²)/线规(平方数)	0.14mm²-0.75mm²
Wire gauge(AWG)/线号(平方数)	26AWG-18AWG
Mechanical operation/插拔次数	>100 mating cycles/大于100次
Ambient temperature (operation)/操作温度	-40°C~+85°C
Contact resistance/接触电阻	≤5mΩ
Insulation resistance/绝缘电阻	≥100MΩ
Connector body/胶芯	TPU
Pins/端子	Phosphorus copper with gold plated/磷铜镀金
Screw/螺丝	Brass with nickel plated/黄铜镀镍
Gasket/胶圈	Fluorine ring/氟胶圈
Environmental compliance/环境符合标准	RoHs, Reach

M12 D code male straight rear panel mount connector, unshielded,solder/M12,D型公头直头后锁面板焊线式, 不带屏蔽

Illustration/尺寸

Product photo/产品图

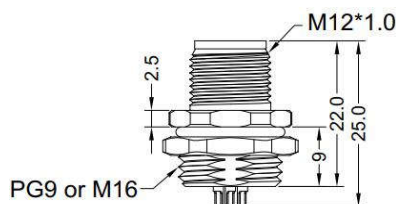

Part number/产品料号

Pins/针数	Code/型	Part number("X" is length millimetre mm)/产品料号("X"表示长度, 单位毫米mm)	
4pins/4针	D code/D型	PG9 thread 15.3±0.1/PG9螺纹15.3±0.1	M16 thread 16±0.1/M16螺纹16±0.1
		12H050-X	12H054-X

Pin assignment front view/针位分布前视图

D code 4pins
D型4针



General data/常规数据

Pins Numbers/针数	4pins/4针
Rated voltage/额定电压	250V
Rated current(40°C)/额定电流	4A
Standards/标准	IEC 61076-2-101
Termination/焊接方式	solder/焊接
Connector locking system/锁紧方式	Screw/螺锁
Degree of protection/防护等级	IP67, IP68, IP69K
Wire gauge(mm²)/线规(平方数)	0.14mm²-0.75mm²
Wire gauge(AWG)/线号(平方数)	26AWG-18AWG
Mechanical operation/插拔次数	>100 mating cycles/大于100次
Ambient temperature (operation)/操作温度	-40°C~+85°C
Contact resistance/接触电阻	≤5mΩ
Insulation resistance/绝缘电阻	≥100MΩ
Connector body/胶芯	TPU
Pins/端子	Brass with gold plated/黄铜镀金
Screw/螺丝	Brass with nickel plated/黄铜镀镍
Gasket/胶圈	Fluorine ring/氟胶圈
Environmental compliance/环境符合标准	RoHs, Reach

M12D code female straight rear panel mount connector, unshielded, solder/M12, D型母头直头后锁面板焊线式, 不带屏蔽

Illustration/尺寸

Product photo/产品图

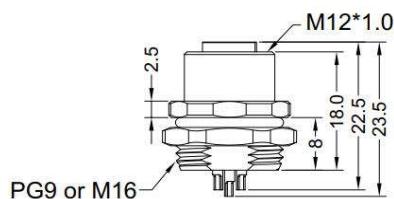

Part number/产品料号

Pins/孔数	Code/型	Part number("X" is length millimetre mm)/产品料号("X"表示长度, 单位毫米mm)	
4pins/4孔	D code/D型	PG9 thread 15.3±0.1/PG9螺纹15.3±0.1	M16 thread 16±0.1/M16螺纹16±0.1
		12H052-X	12H056-X

Pin assignment front view/孔位分布前视图

D code 4pins
D型4孔

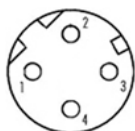

General data/常规数据

Pins Numbers/孔数	4pins/4孔
Rated voltage/额定电压	250V
Rated current(40°C)/额定电流	4A
Standards/标准	IEC 61076-2-101
Termination/焊接方式	solder/焊接
Connector locking system/锁紧方式	Screw/螺锁
Degree of protection/防护等级	IP67, IP68, IP69K
Wire gauge(mm²)/线规(平方数)	0.14mm²-0.75mm²
Wire gauge(AWG)/线号(平方数)	26AWG-18AWG
Mechanical operation/插拔次数	>100 mating cycles/大于100次
Ambient temperature (operation)/操作温度	-40°C~+85°C
Contact resistance/接触电阻	≤5mΩ
Insulation resistance/绝缘电阻	≥100MΩ
Connector body/胶芯	TPU
Pins/端子	Phosphorus copper with gold plated/磷铜镀金
Screw/螺丝	Brass with nickel plated/黄铜镀镍
Gasket/胶圈	Fluorine ring/氟胶圈
Environmental compliance/环境符合标准	RoHs, Reach

M12 D code male straight front panel mount connector, unshielded, single wires/M12, D型公头直头前锁面板带线, 不带屏蔽

Illustration/尺寸

Product photo/产品图

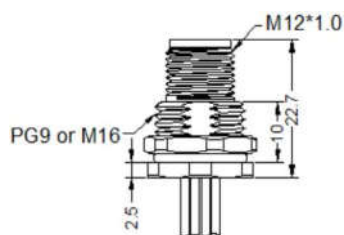

Part number/产品料号

Pins/针数	Code/型	Part number("X" is length millimetre mm)/产品料号("X"表示长度, 单位毫米mm)	
		PG9 thread 15.3±0.1/PG9螺纹15.3±0.1	M16 thread 16±0.1/M16螺纹16±0.1
4pins/4针	D code/D型	12D049-X	12D053-X

Pin assignment front view/针位分布前视图

D code 4pins
D型4针



General data/常规数据

Pins Numbers/针数	4pins/4针
Rated voltage/额定电压	250V
Rated current(40°C)/额定电流	4A
Standards/标准	IEC 61076-2-101
Termination/焊接方式	solder/焊接
Connector locking system/锁紧方式	Screw/螺锁
Degree of protection/防护等级	IP67, IP68, IP69K
Wire gauge(mm²)/线规(平方数)	0.14mm²-0.75mm²
Wire gauge(AWG)/线号(平方数)	26AWG-18AWG
Mechanical operation/插拔次数	>100 mating cycles/大于100次
Ambient temperature (operation)/操作温度	-40°C~+85°C
Contact resistance/接触电阻	≤5mΩ
Insulation resistance/绝缘电阻	≥100MΩ
Connector body/胶芯	TPU
Pins/端子	Brass with gold plated/黄铜镀金
Screw/螺丝	Brass with nickel plated/黄铜镀镍
Gasket/胶圈	Fluorine ring/氟胶圈
Environmental compliance/环境符合标准	RoHs, Reach

M12 D code female straight front panel mount connector, unshielded, single wires/M12, D型母头直头前锁面板带线, 不带屏蔽

Illustration/尺寸

Product photo/产品图

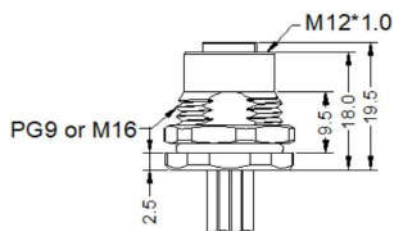

Part number/产品料号

Pins/孔数	Code/型	Part number("X" is length millimetre mm)/产品料号("X"表示长度, 单位毫米mm)	
		PG9 thread 15.3±0.1/PG9螺纹15.3±0.1	M16 thread 16±0.1/M16螺纹16±0.1
4pins/4孔	D code/D型	12D051-X	12D055-X

Pin assignment front view/孔位分布前视图

D code 4pins
D型4孔

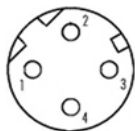

General data/常规数据

Pins Numbers/孔数	4pins/4孔
Rated voltage/额定电压	250V
Rated current(40°C)/额定电流	4A
Standards/标准	IEC 61076-2-101
Termination/焊接方式	solder/焊接
Connector locking system/锁紧方式	Screw/螺锁
Degree of protection/防护等级	IP67, IP68, IP69K
Wire gauge(mm²)/线规(平方数)	0.14mm²-0.75mm²
Wire gauge(AWG)/线号(平方数)	26AWG-18AWG
Mechanical operation/插拔次数	>100 mating cycles/大于100次
Ambient temperature (operation)/操作温度	-40°C~+85°C
Contact resistance/接触电阻	≤5mΩ
Insulation resistance/绝缘电阻	≥100MΩ
Connector body/胶芯	TPU
Pins/端子	Phosphorus copper with gold plated/磷铜镀金
Screw/螺丝	Brass with nickel plated/黄铜镀镍
Gasket/胶圈	Fluorine ring/氟胶圈
Environmental compliance/环境符合标准	RoHs, Reach

M12 D code male straight rear panel mount connector, unshielded, single wires/M12, D型公头直头后锁面板带线, 不带屏蔽

Illustration/尺寸

Product photo/产品图

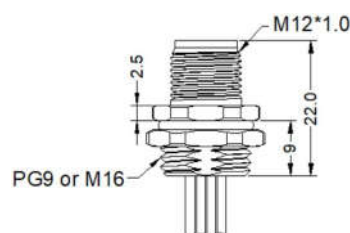

Part number/产品料号

Pins/针数	Code/型	Part number("X" is length millimetre mm)/产品料号("X"表示长度, 单位毫米mm)	
		PG9 thread 15.3±0.1/PG9螺纹15.3±0.1	M16 thread 16±0.1/M16螺纹16±0.1
4pins/4针	D code/D型	12D050-X	12D054-X

Pin assignment front view/针位分布前视图

D code 4pins

D型4针



General data/常规数据

Pins Numbers/针数	4pins/4针
Rated voltage/额定电压	250V
Rated current(40°C)/额定电流	4A
Standards/标准	IEC 61076-2-101
Termination/焊接方式	solder/焊接
Connector locking system/锁紧方式	Screw/螺锁
Degree of protection/防护等级	IP67, IP68, IP69K
Wire gauge(mm²)/线规(平方数)	0.14mm²-0.75mm²
Wire gauge(AWG)/线号(平方数)	26AWG-18AWG
Mechanical operation/插拔次数	>100 mating cycles/大于100次
Ambient temperature (operation)/操作温度	-40°C~+85°C
Contact resistance/接触电阻	≤5mΩ
Insulation resistance/绝缘电阻	≥100MΩ
Connector body/胶芯	TPU
Pins/端子	Brass with gold plated/黄铜镀金
Screw/螺丝	Brass with nickel plated/黄铜镀镍
Gasket/胶圈	Fluorine ring/氟胶圈
Environmental compliance/环境符合标准	RoHs, Reach

M12 D code female straight rear panel mount connector, unshielded, single wires/M12, D型母头直头后锁面板带线, 不带屏蔽

Illustration/尺寸

Product photo/产品图

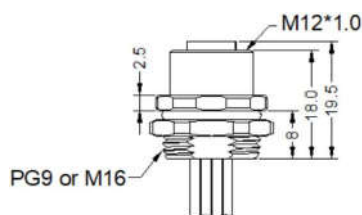

Part number/产品料号

Pins/孔数	Code/型	Part number("X" is length millimetre mm)/产品料号("X"表示长度, 单位毫米mm)	
4pins/4孔	D code/D型	PG9 thread 15.3±0.1/PG9螺纹15.3±0.1	M16 thread 16±0.1/M16螺纹16±0.1
		12D052-X	12D056-X

Pin assignment front view/孔位分布前视图

D code 4pins
D型4孔

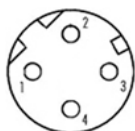

General data/常规数据

Pins Numbers/孔数	4pins/4孔
Rated voltage/额定电压	250V
Rated current(40°C)/额定电流	4A
Standards/标准	IEC 61076-2-101
Termination/焊接方式	solder/焊接
Connector locking system/锁紧方式	Screw/螺锁
Degree of protection/防护等级	IP67, IP68, IP69K
Wire gauge(mm²)/线规(平方数)	0.14mm²-0.75mm²
Wire gauge(AWG)/线号(平方数)	26AWG-18AWG
Mechanical operation/插拔次数	>100 mating cycles/大于100次
Ambient temperature (operation)/操作温度	-40°C~+85°C
Contact resistance/接触电阻	≤5mΩ
Insulation resistance/绝缘电阻	≥100MΩ
Connector body/胶芯	TPU
Pins/端子	Phosphorus copper with gold plated/磷铜镀金
Screw/螺丝	Brass with nickel plated/黄铜镀镍
Gasket/胶圈	Fluorine ring/氟胶圈
Environmental compliance/环境符合标准	RoHs, Reach

M12 D code male straight plastic assembly connector, unshielded/M12, D型公头直头塑胶装配式连接器, 不带屏蔽

Illustration/尺寸

Product photo/产品图

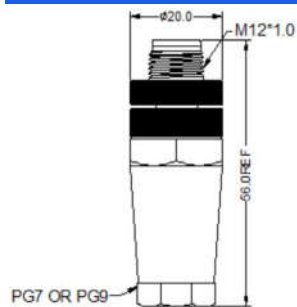

Part number/产品料号

Pins/针数	Code/型	Part number/产品料号	
4pins/4针	D code/D型	PG7 thread/PG7螺纹	PG9 thread/PG9螺纹
		12ZU61-PG7	12ZU61-PG9

Pin assignment front view/针位分布前视图

D code 4pins

D型4针



General data/常规数据

Pins Numbers/针数	4pins/4针
Rated voltage/额定电压	250V
Rated current(40°C)/额定电流	4A
Standards/标准	IEC 61076-2-101
Termination/焊接方式	screw clamp/螺锁
Degree of protection/防护等级	IP67
Wire gauge(mm²)/线规(平方数)	0.14mm²-0.75mm²
Wire gauge(AWG)/线号(平方数)	26AWG-18AWG
Suitable cable outer diameter/适合线材外径	4.0mm-8.0mm
Mechanical operation/插拔次数	>100 mating cycles/大于100次
Ambient temperature (operation)/操作温度	-25°C~+85°C
Contact resistance/接触电阻	≤5mΩ
Insulation resistance/绝缘电阻	≥100MΩ
Connector body/胶芯	TPU
Pins/端子	Brass with gold plated/黄铜镀金
Screw/螺丝	Brass with nickel plated/黄铜镀镍
Gasket/胶圈	Fluorine ring/氟胶圈
PG7: Cable diameter 4mm~6mm	PG9: Cable diameter 6mm~8mm
Environmental compliance/环境符合标准	RoHs, Reach

M12 D code female straight plastic assembly connector, unshielded/M12, D型母头直头塑胶装配式连接器, 不带屏蔽

Illustration/尺寸 Product photo/产品图

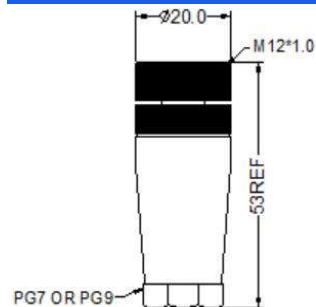

Part number/产品料号

Pins/孔数	Code/型	Part number/产品料号	
4pins/4孔	D code/D型	PG7 thread/PG7螺纹	PG9 thread/PG9螺纹
		12ZU62-PG7	12ZU62-PG9

Pin assignment front view/孔位分布前视图

D code 4pins
D型4孔

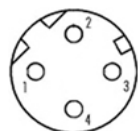

General data/常规数据

Pins Numbers/孔数	4pins/4孔
Rated voltage/额定电压	250V
Rated current(40°C)/额定电流	4A
Standards/标准	IEC 61076-2-101
Termination/焊接方式	screw clamp/螺锁
Degree of protection/防护等级	IP67
Wire gauge(mm²)/线规(平方数)	0.14mm²-0.75mm²
Wire gauge(AWG)/线号(平方数)	26AWG-18AWG
Suitable cable outer diameter/适合线材外径	4.0mm-8.0mm
Mechanical operation/插拔次数	>100 mating cycles/大于100次
Ambient temperature (operation)/操作温度	-25°C~+85°C
Contact resistance/接触电阻	≤5mΩ
Insulation resistance/绝缘电阻	≥100MΩ
Connector body/胶芯	TPU
Pins/端子	Phosphorus copper with gold plated/磷铜镀金
Screw/螺丝	Brass with nickel plated/黄铜镀镍
Gasket/胶圈	Fluorine ring/氟胶圈
PG7: Cable diameter 4mm~6mm	PG9: Cable diameter 6mm~8mm
Environmental compliance/环境符合标准	RoHs, Reach

M12 D code male right angle plastic assembly connector, unshielded/M12, D型公头弯头塑胶装配式连接器, 不带屏蔽

Illustration/尺寸

Product photo/产品图

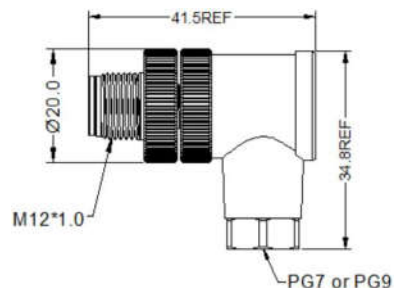

Part number/产品料号

Pins/针数	Code/型	Part number/产品料号	
		PG7 thread/PG7螺纹	PG9 thread/PG9螺纹
4pins/4针	D code/D型	12ZU63-PG7	12ZU63-PG9

Pin assignment front view/针位分布前视图

D code 4pins

D型4针



General data/常规数据

Pins Numbers/针数	4pins/4针
Rated voltage/额定电压	250V
Rated current(40°C)/额定电流	4A
Standards/标准	IEC 61076-2-101
Termination/焊接方式	screw clamp/螺锁
Degree of protection/防护等级	IP67
Wire gauge(mm²)/线规(平方数)	0.14mm²-0.75mm²
Wire gauge(AWG)/线号(平方数)	26AWG-18AWG
Suitable cable outer diameter/适合线材外径	4.0mm-8.0mm
Mechanical operation/插拔次数	>100 mating cycles/大于100次
Ambient temperature (operation)/操作温度	-25°C~+85°C
Contact resistance/接触电阻	≤5mΩ
Insulation resistance/绝缘电阻	≥100MΩ
Connector body/胶芯	TPU
Pins/端子	Brass with gold plated/黄铜镀金
Screw/螺丝	Brass with nickel plated/黄铜镀镍
Gasket/胶圈	Fluorine ring/氟胶圈
PG7: Cable diameter 4mm~6mm	PG9: Cable diameter 6mm~8mm
Environmental compliance/环境符合标准	RoHs, Reach

M12 D code female right angle plastic assembly connector, unshielded/M12, D型母头弯头塑胶装配式连接器, 不带屏蔽

Illustration/尺寸

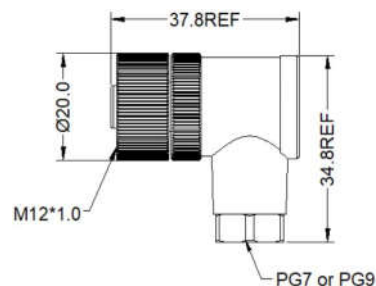

Product photo/产品图



Part number/产品料号

Pins/孔数	Code/型	Part number/产品料号	
		PG7 thread/PG7螺纹	PG9 thread/PG9螺纹
4pins/4孔	D code/D型	12ZU64-PG7	12ZU64-PG9

Pin assignment front view/孔位分布前视图

D code 4pins
D型4孔

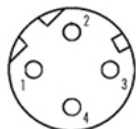

General data/常规数据

Pins Numbers/孔数	4pins/4孔
Rated voltage/额定电压	250V
Rated current(40°C)/额定电流	4A
Standards/标准	IEC 61076-2-101
Termination/焊接方式	screw clamp/螺锁
Degree of protection/防护等级	IP67
Wire gauge(mm²)/线规(平方数)	0.14mm²-0.75mm²
Wire gauge(AWG)/线号(平方数)	26AWG-18AWG
Suitable cable outer diameter/适合线材外径	4.0mm-8.0mm
Mechanical operation/插拔次数	>100 mating cycles/大于100次
Ambient temperature (operation)/操作温度	-25°C~+85°C
Contact resistance/接触电阻	≤5mΩ
Insulation resistance/绝缘电阻	≥100MΩ
Connector body/胶芯	TPU
Pins/端子	Phosphorus copper with gold plated/磷铜镀金
Screw/螺丝	Brass with nickel plated/黄铜镀镍
Gasket/胶圈	Fluorine ring/氟胶圈
PG7: Cable diameter 4mm~6mm	PG9: Cable diameter 6mm~8mm
Environmental compliance/环境符合标准	RoHs, Reach

M12 D code male straight metal assembly connector with shielded/M12, D型公头直头金属装配式连接器, 带屏蔽

Illustration/尺寸

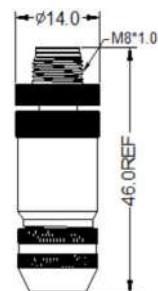

Product photo/产品图



Part number/产品料号

Pins/针数	Code/型	Part number/产品料号	
		PG7 thread/PG7螺纹	PG9 thread/PG9螺纹
4pins/4针	D code/D型	12ZS65-PG7	12ZS65-PG9

Pin assignment front view/针位分布前视图

D code 4pins

D型4针



General data/常规数据

Pins Numbers/针数	4pins/4针
Rated voltage/额定电压	250V
Rated current(40°C)/额定电流	4A
Standards/标准	IEC 61076-2-101
Termination/焊接方式	screw clamp/螺锁
Degree of protection/防护等级	IP67
Wire gauge(mm²)/线规(平方数)	0.14mm²-0.75mm²
Wire gauge(AWG)/线号(平方数)	26AWG-18AWG
Suitable cable outer diameter/适合线材外径	4.0mm-8.0mm
Mechanical operation/插拔次数	>100 mating cycles/大于100次
Ambient temperature (operation)/操作温度	-25°C~+85°C
Contact resistance/接触电阻	≤5mΩ
Insulation resistance/绝缘电阻	≥100MΩ
Connector body/胶芯	TPU
Pins/端子	Brass with gold plated/黄铜镀金
Screw/螺丝	Brass with nickel plated/黄铜镀镍
Gasket/胶圈	Fluorine ring/氟胶圈
PG7: Cable diameter 4mm~6mm	PG9: Cable diameter 6mm~8mm
Environmental compliance/环境符合标准	RoHs, Reach

M12 D code female straight metal assembly connector with shielded/M12, D型母头直头金属装配式连接器, 带屏蔽

Illustration/尺寸

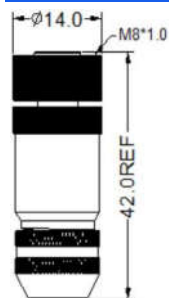

Product photo/产品图



Part number/产品料号

Pins/孔数	Code/型	Part number/产品料号	
4pins/4孔	D code/D型	PG7 thread/PG7螺纹	PG9 thread/PG9螺纹
		12ZS66-PG7	12ZS66-PG9

Pin assignment front view/孔位分布前视图

D code 4pins
D型4孔

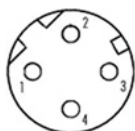

General data/常规数据

Pins Numbers/孔数	4pins/4孔
Rated voltage/额定电压	250V
Rated current(40°C)/额定电流	4A
Standards/标准	IEC 61076-2-101
Termination/焊接方式	screw clamp/螺锁
Degree of protection/防护等级	IP67
Wire gauge(mm²)/线规(平方数)	0.14mm²-0.75mm²
Wire gauge(AWG)/线号(平方数)	26AWG-18AWG
Suitable cable outer diameter/适合线材外径	4.0mm-8.0mm
Mechanical operation/插拔次数	>100 mating cycles/大于100次
Ambient temperature (operation)/操作温度	-25°C~+85°C
Contact resistance/接触电阻	≤5mΩ
Insulation resistance/绝缘电阻	≥100MΩ
Connector body/胶芯	TPU
Pins/端子	Phosphorus copper with gold plated/磷铜镀金
Screw/螺丝	Brass with nickel plated/黄铜镀镍
Gasket/胶圈	Fluorine ring/氟胶圈
PG7: Cable diameter 4mm~6mm	PG9: Cable diameter 6mm~8mm
Environmental compliance/环境符合标准	RoHs, Reach

M12 D code male right angle metal assembly connector with shielded/M12, D型公头弯头金属装配式连接器, 带屏蔽

Illustration/尺寸

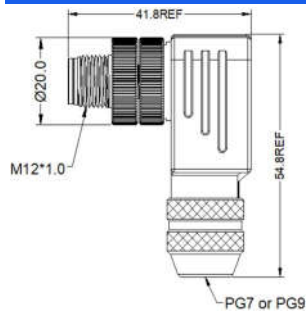

Product photo/产品图



Part number/产品料号

Pins/针数	Code/型	Part number/产品料号	
		PG7 thread/PG7螺纹	PG9 thread/PG9螺纹
4pins/4针	D code/D型	12ZS67-PG7	12ZS67-PG9

Pin assignment front view/针位分布前视图

D code 4pins

D型4针



General data/常规数据

Pins Numbers/针数	4pins/4针
Rated voltage/额定电压	250V
Rated current(40°C)/额定电流	4A
Standards/标准	IEC 61076-2-101
Termination/焊接方式	screw clamp/螺锁
Degree of protection/防护等级	IP67
Wire gauge(mm²)/线规(平方数)	0.14mm²-0.75mm²
Wire gauge(AWG)/线号(平方数)	26AWG-18AWG
Suitable cable outer diameter/适合线材外径	4.0mm-8.0mm
Mechanical operation/插拔次数	>100 mating cycles/大于100次
Ambient temperature (operation)/操作温度	-25°C~+85°C
Contact resistance/接触电阻	≤5mΩ
Insulation resistance/绝缘电阻	≥100MΩ
Connector body/胶芯	TPU
Pins/端子	Brass with gold plated/黄铜镀金
Screw/螺丝	Brass with nickel plated/黄铜镀镍
Gasket/胶圈	Fluorine ring/氟胶圈
PG7: Cable diameter 4mm~6mm	PG9: Cable diameter 6mm~8mm
Environmental compliance/环境符合标准	RoHS, Reach

M12 D code female right angle metal assembly connector with shielded/M12, D型母头弯头金属装配式连接器, 带屏蔽

Illustration/尺寸

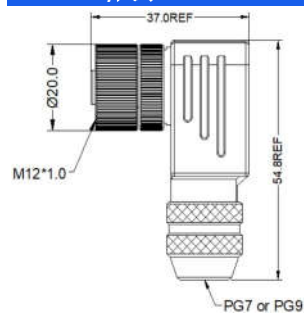

Product photo/产品图



Part number/产品料号

Pins/孔数	Code/型	Part number/产品料号	
		PG7 thread/PG7螺纹	PG9 thread/PG9螺纹
4pins/4孔	D code/D型	12ZS68-PG7	12ZS68-PG9

Pin assignment front view/孔位分布前视图

D code 4pins
D型4孔

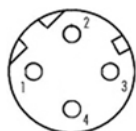

General data/常规数据

Pins Numbers/孔数	4pins/4孔
Rated voltage/额定电压	250V
Rated current(40°C)/额定电流	4A
Standards/标准	IEC 61076-2-101
Termination/焊接方式	screw clamp/螺锁
Degree of protection/防护等级	IP67
Wire gauge(mm²)/线规(平方数)	0.14mm²-0.75mm²
Wire gauge(AWG)/线号(平方数)	26AWG-18AWG
Suitable cable outer diameter/适合线材外径	4.0mm-8.0mm
Mechanical operation/插拔次数	>100 mating cycles/大于100次
Ambient temperature (operation)/操作温度	-25°C~+85°C
Contact resistance/接触电阻	≤5mΩ
Insulation resistance/绝缘电阻	≥100MΩ
Connector body/胶芯	TPU
Pins/端子	Phosphorus copper with gold plated/磷铜镀金
Screw/螺丝	Brass with nickel plated/黄铜镀镍
Gasket/胶圈	Fluorine ring/氟胶圈
PG7: Cable diameter 4mm~6mm	PG9: Cable diameter 6mm~8mm
Environmental compliance/环境符合标准	RoHs, Reach

M12 D code male straight molded cable, unshielded/M12, D型公头直头成型式连接线, 不带屏蔽

Illustration/尺寸

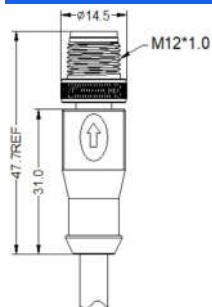

Product photo/产品图



Part number/产品料号

Pins/针数	Code/型	Part number("X" is length millimetre mm)/产品料号("X"表示长度, 单位毫米mm)		
		PVC jacket/PVC外被	PUR jacket/PUR外被	
4pins/4针	D code/D型	-10°C~+80°C	-40°C~+105°C	-40°C~+105°C
		12L00337-X	12L00338-X	12L00339-X

Pin assignment front view/针位分布前视图

D code 4pins
D型4针



General data/常规数据

Pins Numbers/针数	4pins/4针
Rated voltage/额定电压	250V
Rated current(40°C)/额定电流	4A
Standards/标准	IEC 61076-2-101
Termination/焊接方式	solder and over-mold/焊接和成型
Degree of protection/防护等级	IP67, IP68, IP69K
Wire gauge(mm²)/线规(平方数)	0.14mm²-0.75mm²
Wire gauge(AWG)/线号(平方数)	26AWG-18AWG
Mechanical operation/插拔次数	>100 mating cycles/大于100次
Contact resistance/接触电阻	≤5mΩ
Insulation resistance/绝缘电阻	≥100MΩ
Connector body/胶芯	TPU
Pins/端子	Brass with gold plated/黄铜镀金
Screw/螺丝	Brass with nickel plated/黄铜镀镍
Environmental compliance/环境符合标准	RoHs, Reach

M12 D code female straight molded cable, unshielded/M12, D型母头直头成型式连接线, 不带屏蔽

Illustration/尺寸

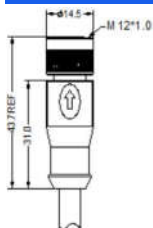

Product photo/产品图



Part number/产品料号

Pins/孔数	Code/型	Part number("X" is length millimetre mm)/产品料号("X"表示长度, 单位毫米mm)		
		PVC jacket/PVC外被	PUR jacket/PUR外被	
		-10°C~+80°C	-40°C~+105°C	-40°C~+105°C
4pins/4孔	D code/D型	12L00340-X	12L00341-X	12L00342-X

Pin assignment front view/孔位分布前视图

D code 4pins
D型4孔

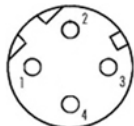

General data/常规数据

Pins Numbers/孔数	4pins/4孔
Rated voltage/额定电压	250V
Rated current(40°C)/额定电流	4A
Standards/标准	IEC 61076-2-101
Termination/焊接方式	solder and over-mold/焊接和成型
Degree of protection/防护等级	IP67, IP68, IP69K
Wire gauge(mm²)/线规(平方数)	0.14mm²-0.75mm²
Wire gauge(AWG)/线号(平方数)	26AWG-18AWG
Mechanical operation/插拔次数	>100 mating cycles/大于100次
Contact resistance/接触电阻	≤5mΩ
Insulation resistance/绝缘电阻	≥100MΩ
Connector body/胶芯	TPU
Pins/端子	Phosphorus copper with gold plated/磷铜镀金
Screw/螺丝	Brass with nickel plated/黄铜镀镍
Environmental compliance/环境符合标准	RoHs, Reach

M12 D code male straight molded cable, shielded/M12, D型公头直头成型式连接线, 带屏蔽

Illustration/尺寸

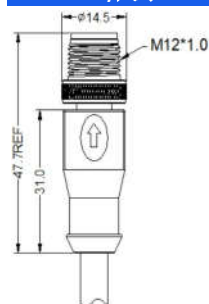

Product photo/产品图



Part number/产品料号

Pins/针数	Code/型	Part number("X" is length millimetre mm)/产品料号("X"表示长度, 单位毫米mm)		
		PVC jacket/PVC外被	PUR jacket/PUR外被	
4pins/4针	D code/D型	-10°C~+80°C	-40°C~+105°C	-40°C~+105°C
		12L00349-X	12L00350-X	12L00351-X

Pin assignment front view/针位分布前视图

D code 4pins
D型4针



General data/常规数据

Pins Numbers/针数	4pins/4针
Rated voltage/额定电压	250V
Rated current(40°C)/额定电流	4A
Standards/标准	IEC 61076-2-101
Termination/焊接方式	solder and over-mold/焊接和成型
Degree of protection/防护等级	IP67, IP68, IP69K
Wire gauge(mm²)/线规(平方数)	0.14mm²-0.75mm²
Wire gauge(AWG)/线号(平方数)	26AWG-18AWG
Mechanical operation/插拔次数	>100 mating cycles/大于100次
Contact resistance/接触电阻	≤5mΩ
Insulation resistance/绝缘电阻	≥100MΩ
Connector body/胶芯	TPU
Pins/端子	Brass with gold plated/黄铜镀金
Screw/螺丝	Brass with nickel plated/黄铜镀镍
Environmental compliance/环境符合标准	RoHs, Reach

M12 D code female straight molded cable, shielded/M12, D型母头直头成型式连接线, 带屏蔽

Illustration/尺寸

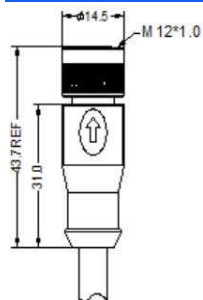

Product photo/产品图



Part number/产品料号

Pins/孔数	Code/型	Part number("X" is length millimetre mm)/产品料号("X"表示长度, 单位毫米mm)		
		PVC jacket/PVC外被	PUR jacket/PUR外被	
4pins/4孔	D code/D型	-10°C~+80°C	-40°C~+105°C	-40°C~+105°C
		12L00352-X	12L00353-X	12L00354-X

Pin assignment front view/孔位分布前视图

D code 4pins
D型4孔

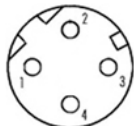

General data/常规数据

Pins Numbers/孔数	4pins/4孔
Rated voltage/额定电压	250V
Rated current(40°C)/额定电流	4A
Standards/标准	IEC 61076-2-101
Termination/焊接方式	solder and over-mold/焊接和成型
Degree of protection/防护等级	IP67, IP68, IP69K
Wire gauge(mm²)/线规(平方数)	0.14mm²-0.75mm²
Wire gauge(AWG)/线号(平方数)	26AWG-18AWG
Mechanical operation/插拔次数	>100 mating cycles/大于100次
Contact resistance/接触电阻	≤5mΩ
Insulation resistance/绝缘电阻	≥100MΩ
Connector body/胶芯	TPU
Pins/端子	Phosphorus copper with gold plated/磷铜镀金
Screw/螺丝	Brass with nickel plated/黄铜镀镍
Environmental compliance/环境符合标准	RoHs, Reach

M12 D code male right angle molded cable, unshielded/M12, D型公头弯头成型式连接线, 不带屏蔽

Illustration/尺寸

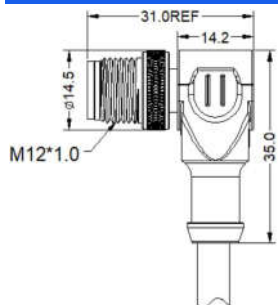

Product photo/产品图



Part number/产品料号

Pins/针数	Code/型	Part number("X" is length millimetre mm)/产品料号("X"表示长度, 单位毫米mm)		
		PVC jacket/PVC外被	PUR jacket/PUR外被	
4pins/4针	D code/D型	-10°C~+80°C	-40°C~+105°C	-40°C~+105°C
		12L00343-X	12L00344-X	12L00345-X

Pin assignment front view/针位分布前视图

D code 4pins
D型4针



General data/常规数据

Pins Numbers/针数	4pins/4针
Rated voltage/额定电压	250V
Rated current(40°C)/额定电流	4A
Standards/标准	IEC 61076-2-101
Termination/焊接方式	solder and over-mold/焊接和成型
Degree of protection/防护等级	IP67, IP68, IP69K
Wire gauge(mm²)/线规(平方数)	0.14mm²-0.75mm²
Wire gauge(AWG)/线号(平方数)	26AWG-18AWG
Mechanical operation/插拔次数	>100 mating cycles/大于100次
Contact resistance/接触电阻	≤5mΩ
Insulation resistance/绝缘电阻	≥100MΩ
Connector body/胶芯	TPU
Pins/端子	Brass with gold plated/黄铜镀金
Screw/螺丝	Brass with nickel plated/黄铜镀镍
Environmental compliance/环境符合标准	RoHS, Reach

M12 D code female right angle molded cable, unshielded/M12, D型母头弯头成型式连接线, 不带屏蔽

Illustration/尺寸

Product photo/产品图

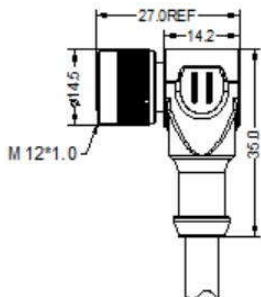

Part number/产品料号

Pins/孔数	Code/型	Part number("X" is length millimetre mm)/产品料号("X"表示长度, 单位毫米mm)		
		PVC jacket/PVC外被	PUR jacket/PUR外被	
4pins/4孔	D code/D型	-10°C~+80°C	-40°C~+105°C	-40°C~+105°C
		12L00346-X	12L00347-X	12L00348-X

Pin assignment front view/孔位分布前视图

D code 4pins
D型4孔

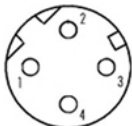

General data/常规数据

Pins Numbers/孔数	4pins/4孔
Rated voltage/额定电压	250V
Rated current(40°C)/额定电流	4A
Standards/标准	IEC 61076-2-101
Termination/焊接方式	solder and over-mold/焊接和成型
Degree of protection/防护等级	IP67, IP68, IP69K
Wire gauge(mm²)/线规(平方数)	0.14mm²-0.75mm²
Wire gauge(AWG)/线号(平方数)	26AWG-18AWG
Mechanical operation/插拔次数	>100 mating cycles/大于100次
Contact resistance/接触电阻	≤5mΩ
Insulation resistance/绝缘电阻	≥100MΩ
Connector body/胶芯	TPU
Pins/端子	Phosphorus copper with gold plated/磷铜镀金
Screw/螺丝	Brass with nickel plated/黄铜镀镍
Environmental compliance/环境符合标准	RoHs, Reach

M12 D code male right angle molded cable, shielded/M12, D型公头弯头成型式连接线, 带屏蔽

Illustration/尺寸

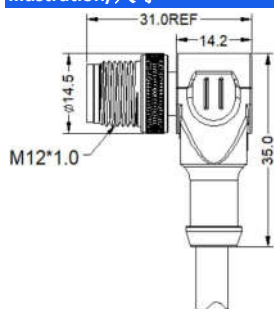

Product photo/产品图



Part number/产品料号

Pins/针数	Code/型	Part number("X" is length millimetre mm)/产品料号("X"表示长度, 单位毫米mm)		
		PVC jacket/PVC外被	PUR jacket/PUR外被	
4pins/4针	D code/D型	-10°C~+80°C	-40°C~+105°C	-40°C~+105°C
		12L00355-X	12L00356-X	12L00357-X

Pin assignment front view/针位分布前视图

D code 4pins
D型4针



General data/常规数据

Pins Numbers/针数	4pins/4针
Rated voltage/额定电压	250V
Rated current(40°C)/额定电流	4A
Standards/标准	IEC 61076-2-101
Termination/焊接方式	solder and over-mold/焊接和成型
Degree of protection/防护等级	IP67, IP68, IP69K
Wire gauge(mm²)/线规(平方数)	0.14mm²-0.75mm²
Wire gauge(AWG)/线号(平方数)	26AWG-18AWG
Mechanical operation/插拔次数	>100 mating cycles/大于100次
Contact resistance/接触电阻	≤5mΩ
Insulation resistance/绝缘电阻	≥100MΩ
Connector body/胶芯	TPU
Pins/端子	Brass with gold plated/黄铜镀金
Screw/螺丝	Brass with nickel plated/黄铜镀镍
Environmental compliance/环境符合标准	RoHs, Reach

M12 D code female right angle molded cable, shielded/M12, D型母头弯头成型式连接线, 带屏蔽

Illustration/尺寸

Product photo/产品图

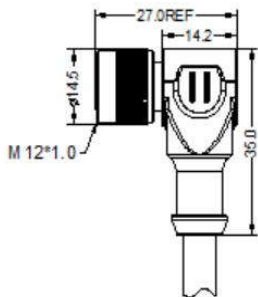

Part number/产品料号

Pins/孔数	Code/型	Part number("X" is length millimetre mm)/产品料号("X"表示长度, 单位毫米mm)		
		PVC jacket/PVC外被	PUR jacket/PUR外被	
4pins/4孔	D code/D型	-10°C~+80°C	-40°C~+105°C	-40°C~+105°C
		12L00358-X	12L00359-X	12L00360-X

Pin assignment front view/孔位分布前视图

D code 4pins
D型4孔

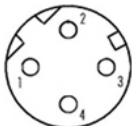

General data/常规数据

Pins Numbers/孔数	4pins/4孔
Rated voltage/额定电压	250V
Rated current(40°C)/额定电流	4A
Standards/标准	IEC 61076-2-101
Termination/焊接方式	solder and over-mold/焊接和成型
Degree of protection/防护等级	IP67, IP68, IP69K
Wire gauge(mm²)/线规(平方数)	0.14mm²-0.75mm²
Wire gauge(AWG)/线号(平方数)	26AWG-18AWG
Mechanical operation/插拔次数	>100 mating cycles/大于100次
Contact resistance/接触电阻	≤5mΩ
Insulation resistance/绝缘电阻	≥100MΩ
Connector body/胶芯	TPU
Pins/端子	Phosphorus copper with gold plated/磷铜镀金
Screw/螺丝	Brass with nickel plated/黄铜镀镍
Environmental compliance/环境符合标准	RoHs, Reach

M12 D code male to male right angle molded cable, unshielded/M12, D型公头弯头对公头弯头连接线, 不带屏蔽

Illustration/尺寸

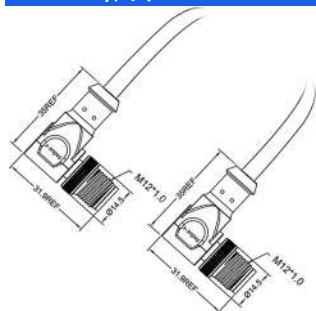

Product photo/产品图



Part number/产品料号

Pins/针数	Code/型	Part number("X" is length millimetre mm)/产品料号("X"表示长度, 单位毫米mm)		
		PVC jacket/PVC外被	PUR jacket/PUR外被	
4pins/4针	D code/D型	-10°C~+80°C	-40°C~+105°C	-40°C~+105°C
		12L00946-X	12L00947-X	12L00948-X

Pin assignment front view/针位分布前视图

D code 4pins
D型4针



General data/常规数据

Pins Numbers/针数	4pins/4针
Rated voltage/额定电压	250V
Rated current(40°C)/额定电流	4A
Standards/标准	IEC 61076-2-101
Termination/焊接方式	solder and over-mold/焊接和成型
Degree of protection/防护等级	IP67, IP68, IP69K
Wire gauge(mm²)/线规(平方数)	0.14mm²-0.75mm²
Wire gauge(AWG)/线号(平方数)	26AWG-18AWG
Mechanical operation/插拔次数	>100 mating cycles/大于100次
Contact resistance/接触电阻	≤5mΩ
Insulation resistance/绝缘电阻	≥100MΩ
Connector body/胶芯	TPU
Pins/端子	Brass with gold plated/黄铜镀金
Screw/螺丝	Brass with nickel plated/黄铜镀镍
Environmental compliance/环境符合标准	RoHs, Reach

M12 D code male to female right angle molded cable, unshielded/M12, D型公头弯头对母头弯头连接线, 不带屏蔽

Illustration/尺寸

Product photo/产品图

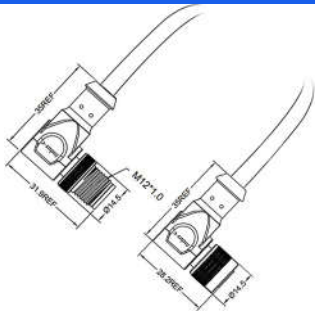

Part number/产品料号

Pins/针数	Code/型	Part number("X" is length millimetre mm)/产品料号("X"表示长度, 单位毫米mm)		
		PVC jacket/PVC外被	PUR jacket/PUR外被	
4pins/4针	D code/D型	-10°C~+80°C	-40°C~+105°C	-40°C~+105°C
		12L00952-X	12L00953-X	12L00954-X

Pin assignment front view/针位分布前视图

D code 4pins
D型4针



D型4针

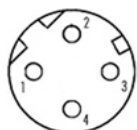

General data/常规数据

Pins Numbers/针数	4pins/4针
Rated voltage/额定电压	250V
Rated current(40°C)/额定电流	4A
Standards/标准	IEC 61076-2-101
Termination/焊接方式	solder and over-mold/焊接和成型
Degree of protection/防护等级	IP67, IP68, IP69K
Wire gauge(mm²)/线规(平方数)	0.14mm²-0.75mm²
Wire gauge(AWG)/线号(平方数)	26AWG-18AWG
Mechanical operation/插拔次数	>100 mating cycles/大于100次
Contact resistance/接触电阻	≤5mΩ
Insulation resistance/绝缘电阻	≥100MΩ
Connector body/胶芯	TPU
Male pin/公端子	Brass with gold plated/黄铜镀金
Female pin/母端子	Phosphorus copper with gold plated/磷铜镀金
Screw/螺丝	Brass with nickel plated/黄铜镀镍
Over-mold/成型	TPU
Environmental compliance/环境符合标准	RoHs, Reach

M12 D code male right angle to female straight molded cable, unshielded/M12, D型公头弯头对母头直头成型式连接线, 不带屏蔽

Illustration/尺寸

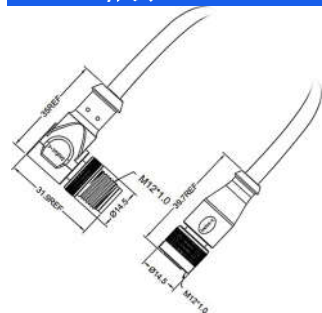

Product photo/产品图



Part number/产品料号

Pins/针数	Code/型	Part number("X" is length millimetre mm)/产品料号("X"表示长度, 单位毫米mm)		
		PVC jacket/PVC外被	PUR jacket/PUR外被	
4pins/4针	D code/D型	-10°C~+80°C	-40°C~+105°C	-40°C~+105°C
		12L00958-X	12L00959-X	12L00817-X

Pin assignment front view/针位分布前视图

D code 4pins
D型4针



D型4针

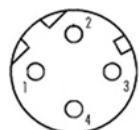

General data/常规数据

Pins Numbers/针数	4pins/4针
Rated voltage/额定电压	250V
Rated current(40°C)/额定电流	4A
Standards/标准	IEC 61076-2-101
Termination/焊接方式	solder and over-mold/焊接和成型
Degree of protection/防护等级	IP67, IP68, IP69K
Wire gauge(mm²)/线规(平方数)	0.14mm²-0.75mm²
Wire gauge(AWG)/线号(平方数)	26AWG-18AWG
Mechanical operation/插拔次数	>100 mating cycles/大于100次
Contact resistance/接触电阻	≤5mΩ
Insulation resistance/绝缘电阻	≥100MΩ
Connector body/胶芯	TPU
Male pin/公端子	Brass with gold plated/黄铜镀金
Female pin/母端子	Phosphorus copper with gold plated/磷铜镀金
Screw/螺丝	Brass with nickel plated/黄铜镀镍
Over-mold/成型	TPU
Environmental compliance/环境符合标准	RoHs, Reach

M12 D code male straight to male right angle molded cable, unshielded/M12, A型公头直头对公头弯头连接线, 不带屏蔽

Illustration/尺寸

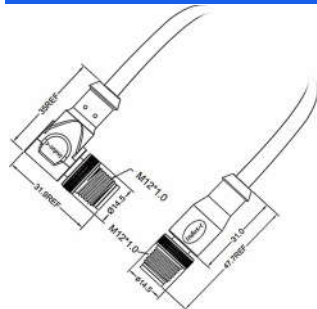

Product photo/产品图



Part number/产品料号

Pins/针数	Code/型	Part number("X" is length millimetre mm)/产品料号("X"表示长度, 单位毫米mm)		
		PVC jacket/PVC外被	PUR jacket/PUR外被	
		-10°C~+80°C	-40°C~+105°C	-40°C~+105°C
4pins/4针	D code/D型	12L00963-X	12L00964-X	12L00965-X

Pin assignment front view/针位分布前视图

D code 4pins
D型4针



General data/常规数据

Pins Numbers/针数	4pins/4针
Rated voltage/额定电压	250V
Rated current(40°C)/额定电流	4A
Standards/标准	IEC 61076-2-101
Termination/焊接方式	solder and over-mold/焊接和成型
Degree of protection/防护等级	IP67, IP68, IP69K
Wire gauge(mm²)/线规(平方数)	0.14mm²-0.75mm²
Wire gauge(AWG)/线号(平方数)	26AWG-18AWG
Mechanical operation/插拔次数	>100 mating cycles/大于100次
Contact resistance/接触电阻	≤5mΩ
Insulation resistance/绝缘电阻	≥100MΩ
Connector body/胶芯	TPU
Pins/端子	Brass with gold plated/黄铜镀金
Screw/螺丝	Brass with nickel plated/黄铜镀镍
Environmental compliance/环境符合标准	RoHs, Reach

M12 D code male to male straight molded cable, unshielded/M12, D型公头直头对公头直头连接线, 不带屏蔽

Illustration/尺寸

Product photo/产品图

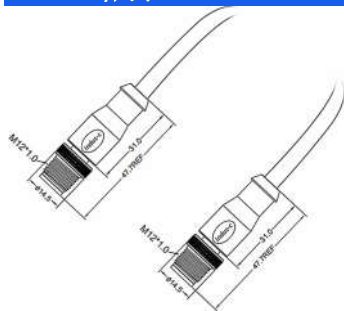

Part number/产品料号

Pins/针数	Code/型	Part number("X" is length millimetre mm)/产品料号("X"表示长度, 单位毫米mm)		
		PVC jacket/PVC外被	PUR jacket/PUR外被	
4pins/4针	D code/D型	-10°C~+80°C	-40°C~+105°C	-40°C~+105°C
		12L00969-X	12L00970-X	12L00971-X

Pin assignment front view/针位分布前视图

D code 4pins
D型4针



General data/常规数据

Pins Numbers/针数	4pins/4针
Rated voltage/额定电压	250V
Rated current(40°C)/额定电流	4A
Standards/标准	IEC 61076-2-101
Termination/焊接方式	solder and over-mold/焊接和成型
Degree of protection/防护等级	IP67, IP68, IP69K
Wire gauge(mm²)/线规(平方数)	0.14mm²-0.75mm²
Wire gauge(AWG)/线号(平方数)	26AWG-18AWG
Mechanical operation/插拔次数	>100 mating cycles/大于100次
Contact resistance/接触电阻	≤5mΩ
Insulation resistance/绝缘电阻	≥100MΩ
Connector body/胶芯	TPU
Pins/端子	Brass with gold plated/黄铜镀金
Screw/螺丝	Brass with nickel plated/黄铜镀镍
Environmental compliance/环境符合标准	RoHs, Reach

M12 D code male straight to female right angle molded cable, unshielded/M12, D型公头直头对母头弯头连接线, 不带屏蔽

Illustration/尺寸

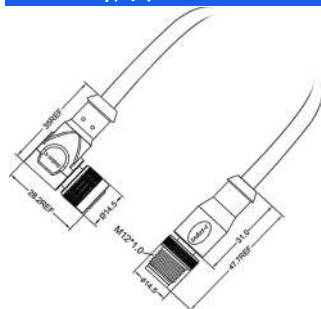

Product photo/产品图



Part number/产品料号

Pins/针数	Code/型	Part number("X" is length millimetre mm)/产品料号("X"表示长度, 单位毫米mm)		
		PVC jacket/PVC外被	PUR jacket/PUR外被	
4pins/4针	D code/D型	-10°C~+80°C	-40°C~+105°C	-40°C~+105°C
		12L00975-X	12L00976-X	12L00977-X

Pin assignment front view/针位分布前视图

D code 4pins
D型4针



D型4针

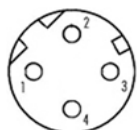

General data/常规数据

Pins Numbers/针数	4pins/4针
Rated voltage/额定电压	250V
Rated current(40°C)/额定电流	4A
Standards/标准	IEC 61076-2-101
Termination/焊接方式	solder and over-mold/焊接和成型
Degree of protection/防护等级	IP67, IP68, IP69K
Wire gauge(mm²)/线规(平方数)	0.14mm²-0.75mm²
Wire gauge(AWG)/线号(平方数)	26AWG-18AWG
Mechanical operation/插拔次数	>100 mating cycles/大于100次
Contact resistance/接触电阻	≤5mΩ
Insulation resistance/绝缘电阻	≥100MΩ
Connector body/胶芯	TPU
Male pin/公端子	Brass with gold plated/黄铜镀金
Female pin/母端子	Phosphorus copper with gold plated/磷铜镀金
Screw/螺丝	Brass with nickel plated/黄铜镀镍
Over-mold/成型	TPU
Environmental compliance/环境符合标准	RoHs, Reach

M12 D code male to female straight molded cable, unshielded/M12, D型公头直头对母头直头连接线, 不带屏蔽

Illustration/尺寸

Product photo/产品图

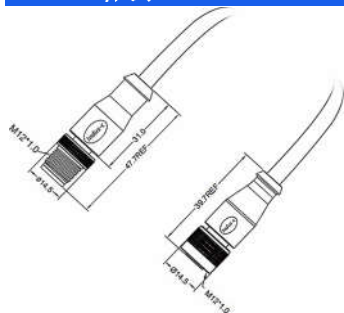

Part number/产品料号

Pins/针数	Code/型	Part number("X" is length millimetre mm)/产品料号("X"表示长度, 单位毫米mm)		
		PVC jacket/PVC外被	PUR jacket/PUR外被	
4pins/4针	D code/D型	-10°C~+80°C	-40°C~+105°C	-40°C~+105°C
		12L00981-X	12L00982-X	12L00821-X

Pin assignment front view/针位分布前视图

D code 4pins
D型4针



D型4针

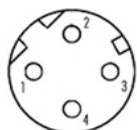

General data/常规数据

Pins Numbers/针数	4pins/4针
Rated voltage/额定电压	250V
Rated current(40°C)/额定电流	4A
Standards/标准	IEC 61076-2-101
Termination/焊接方式	solder and over-mold/焊接和成型
Degree of protection/防护等级	IP67, IP68, IP69K
Wire gauge(mm²)/线规(平方数)	0.14mm²-0.75mm²
Wire gauge(AWG)/线号(平方数)	26AWG-18AWG
Mechanical operation/插拔次数	>100 mating cycles/大于100次
Contact resistance/接触电阻	≤5mΩ
Insulation resistance/绝缘电阻	≥100MΩ
Connector body/胶芯	TPU
Male pin/公端子	Brass with gold plated/黄铜镀金
Female pin/母端子	Phosphorus copper with gold plated/磷铜镀金
Screw/螺丝	Brass with nickel plated/黄铜镀镍
Over-mold/成型	TPU
Environmental compliance/环境符合标准	RoHs, Reach

M12 D code female to female right angle molded cable, unshielded/M12, D型母头弯头对母头弯头连接线, 不带屏蔽

Illustration/尺寸

Product photo/产品图

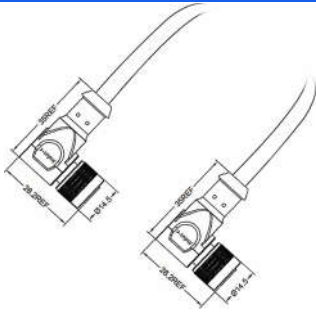

Part number/产品料号

Pins/孔数	Code/型	Part number("X" is length millimetre mm)/产品料号("X"表示长度, 单位毫米mm)		
		PVC jacket/PVC外被	PUR jacket/PUR外被	
4pins/4孔	D code/D型	-10°C~+80°C	-40°C~+105°C	-40°C~+105°C
		12L00985-X	12L00986-X	12L00987-X

Pin assignment front view/孔位分布前视图

D code 4pins
D型4孔

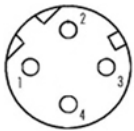

General data/常规数据

Pins Numbers/孔数	4pins/4孔
Rated voltage/额定电压	250V
Rated current(40°C)/额定电流	4A
Standards/标准	IEC 61076-2-101
Termination/焊接方式	solder and over-mold/焊接和成型
Degree of protection/防护等级	IP67, IP68, IP69K
Wire gauge(mm²)/线规(平方数)	0.14mm²-0.75mm²
Wire gauge(AWG)/线号(平方数)	26AWG-18AWG
Mechanical operation/插拔次数	>100 mating cycles/大于100次
Contact resistance/接触电阻	≤5mΩ
Insulation resistance/绝缘电阻	≥100MΩ
Connector body/胶芯	TPU
Pins/端子	Phosphorus copper with gold plated/磷铜镀金
Screw/螺丝	Brass with nickel plated/黄铜镀镍
Environmental compliance/环境符合标准	RoHs, Reach

M12 D code female straight to female right angle molded cable, unshielded/M12, D型母头直头对母头弯头连接线, 不带屏蔽

Illustration/尺寸

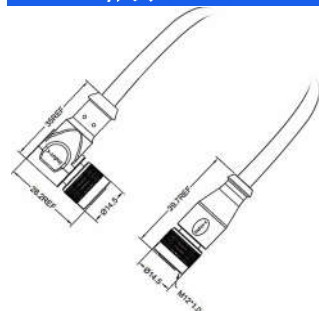

Product photo/产品图



Part number/产品料号

Pins/孔数	Code/型	Part number("X" is length millimetre mm)/产品料号("X"表示长度, 单位毫米mm)		
		PVC jacket/PVC外被	PUR jacket/PUR外被	
4pins/4孔	D code/D型	-10°C~+80°C	-40°C~+105°C	-40°C~+105°C
		12L00991-X	12L00992-X	12L00993-X

Pin assignment front view/孔位分布前视图

D code 4pins
D型4孔

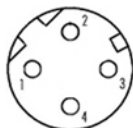

General data/常规数据

Pins Numbers/孔数	4pins/4孔
Rated voltage/额定电压	250V
Rated current(40°C)/额定电流	4A
Standards/标准	IEC 61076-2-101
Termination/焊接方式	solder and over-mold/焊接和成型
Degree of protection/防护等级	IP67, IP68, IP69K
Wire gauge(mm²)/线规(平方数)	0.14mm²-0.75mm²
Wire gauge(AWG)/线号(平方数)	26AWG-18AWG
Mechanical operation/插拔次数	>100 mating cycles/大于100次
Contact resistance/接触电阻	≤5mΩ
Insulation resistance/绝缘电阻	≥100MΩ
Connector body/胶芯	TPU
Pins/端子	Phosphorus copper with gold plated/磷铜镀金
Screw/螺丝	Brass with nickel plated/黄铜镀镍
Environmental compliance/环境符合标准	RoHs, Reach

M12 D code female to female straight molded cable, unshielded/M12,D型母头直头对母头直头连接线, 不带屏蔽

Illustration/尺寸

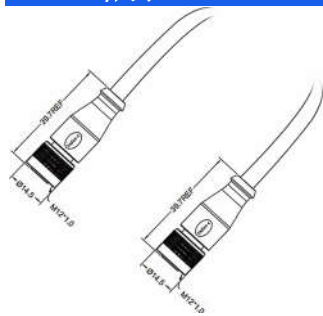

Product photo/产品图



Part number/产品料号

Pins/孔数	Code/型	Part number("X" is length millimetre mm)/产品料号("X"表示长度, 单位毫米mm)		
		PVC jacket/PVC外被	PUR jacket/PUR外被	
4pins/4孔	D code/D型	-10°C~+80°C	-40°C~+105°C	-40°C~+105°C
		12L00997-X	12L00998-X	12L00945-X

Pin assignment front view/孔位分布前视图

D code 4pins
D型4孔

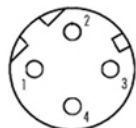

General data/常规数据

Pins Numbers/孔数	4pins/4孔
Rated voltage/额定电压	250V
Rated current(40°C)/额定电流	4A
Standards/标准	IEC 61076-2-101
Termination/焊接方式	solder and over-mold/焊接和成型
Degree of protection/防护等级	IP67, IP68, IP69K
Wire gauge(mm²)/线规(平方数)	0.14mm²-0.75mm²
Wire gauge(AWG)/线号(平方数)	26AWG-18AWG
Mechanical operation/插拔次数	>100 mating cycles/大于100次
Contact resistance/接触电阻	≤5mΩ
Insulation resistance/绝缘电阻	≥100MΩ
Connector body/胶芯	TPU
Pins/端子	Phosphorus copper with gold plated/磷铜镀金
Screw/螺丝	Brass with nickel plated/黄铜镀镍
Environmental compliance/环境符合标准	RoHs, Reach

M12 D code male to male right angle molded cable, shielded/M12, D型公头弯头对公头弯头连接线, 带屏蔽

Illustration/尺寸

Product photo/产品图

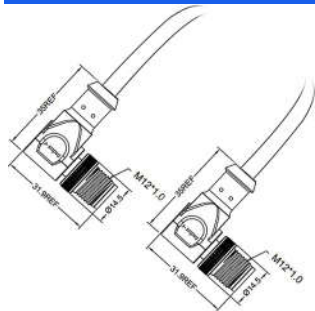

Part number/产品料号

Pins/针数	Code/型	Part number("X" is length millimetre mm)/产品料号("X"表示长度, 单位毫米mm)		
		PVC jacket/PVC外被	PUR jacket/PUR外被	
4pins/4针	D code/D型	-10°C~+80°C	-40°C~+105°C	-40°C~+105°C
		12L00949-X	12L00950-X	12L00951-X

Pin assignment front view/针位分布前视图

D code 4pins
D型4针



General data/常规数据

Pins Numbers/针数	4pins/4针
Rated voltage/额定电压	250V
Rated current(40°C)/额定电流	4A
Standards/标准	IEC 61076-2-101
Termination/焊接方式	solder and over-mold/焊接和成型
Degree of protection/防护等级	IP67, IP68, IP69K
Wire gauge(mm²)/线规(平方数)	0.14mm²-0.75mm²
Wire gauge(AWG)/线号(平方数)	26AWG-18AWG
Mechanical operation/插拔次数	>100 mating cycles/大于100次
Contact resistance/接触电阻	≤5mΩ
Insulation resistance/绝缘电阻	≥100MΩ
Connector body/胶芯	TPU
Pins/端子	Brass with gold plated/黄铜镀金
Screw/螺丝	Brass with nickel plated/黄铜镀镍
Environmental compliance/环境符合标准	RoHs, Reach

M12 D code male to female right angle molded cable, shielded/M12, D型公头弯头对母头弯头连接线, 带屏蔽

Illustration/尺寸

Product photo/产品图

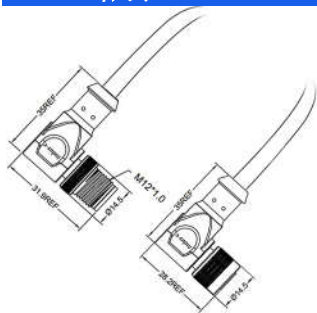

Part number/产品料号

Pins/针数	Code/型	Part number("X" is length millimetre mm)/产品料号("X"表示长度, 单位毫米mm)		
		PVC jacket/PVC外被	PUR jacket/PUR外被	
4pins/4针	D code/D型	-10°C~+80°C	-40°C~+105°C	-40°C~+105°C
		12L00955-X	12L00956-X	12L00957-X

Pin assignment front view/针位分布前视图

D code 4pins
D型4针



D型4针

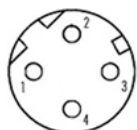

General data/常规数据

Pins Numbers/针数	4pins/4针
Rated voltage/额定电压	250V
Rated current(40°C)/额定电流	4A
Standards/标准	IEC 61076-2-101
Termination/焊接方式	solder and over-mold/焊接和成型
Degree of protection/防护等级	IP67, IP68, IP69K
Wire gauge(mm²)/线规(平方数)	0.14mm²-0.75mm²
Wire gauge(AWG)/线号(平方数)	26AWG-18AWG
Mechanical operation/插拔次数	>100 mating cycles/大于100次
Contact resistance/接触电阻	≤5mΩ
Insulation resistance/绝缘电阻	≥100MΩ
Connector body/胶芯	TPU
Male pin/公端子	Brass with gold plated/黄铜镀金
Female pin/母端子	Phosphorus copper with gold plated/磷铜镀金
Screw/螺丝	Brass with nickel plated/黄铜镀镍
Over-mold/成型	TPU
Environmental compliance/环境符合标准	RoHs, Reach

M12 D code male right angle to female straight molded cable, shielded/M12, D型公头弯头对母头直头成型式连接线, 带屏蔽

Illustration/尺寸

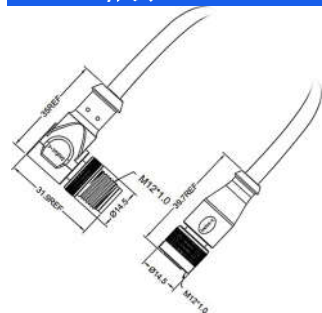

Product photo/产品图



Part number/产品料号

Pins/针数	Code/型	Part number("X" is length millimetre mm)/产品料号("X"表示长度, 单位毫米mm)		
		PVC jacket/PVC外被	PUR jacket/PUR外被	
4pins/4针	D code/D型	-10°C~+80°C	-40°C~+105°C	-40°C~+105°C
		12L00960-X	12L00961-X	12L00962-X

Pin assignment front view/针位分布前视图

D code 4pins
D型4针



D型4针

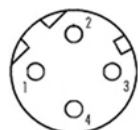

General data/常规数据

Pins Numbers/针数	4pins/4针
Rated voltage/额定电压	250V
Rated current(40°C)/额定电流	4A
Standards/标准	IEC 61076-2-101
Termination/焊接方式	solder and over-mold/焊接和成型
Degree of protection/防护等级	IP67, IP68, IP69K
Wire gauge(mm²)/线规(平方数)	0.14mm²-0.75mm²
Wire gauge(AWG)/线号(平方数)	26AWG-18AWG
Mechanical operation/插拔次数	>100 mating cycles/大于100次
Contact resistance/接触电阻	≤5mΩ
Insulation resistance/绝缘电阻	≥100MΩ
Connector body/胶芯	TPU
Male pin/公端子	Brass with gold plated/黄铜镀金
Female pin/母端子	Phosphorus copper with gold plated/磷铜镀金
Screw/螺丝	Brass with nickel plated/黄铜镀镍
Over-mold/成型	TPU
Environmental compliance/环境符合标准	RoHs, Reach

M12 D code male straight to male right angle molded cable, shielded/M12, A型公头直头对公头弯头连接线, 带屏蔽

Illustration/尺寸

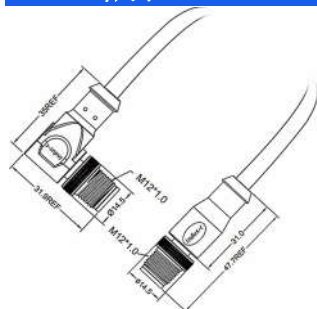

Product photo/产品图



Part number/产品料号

Pins/针数	Code/型	Part number("X" is length millimetre mm)/产品料号("X"表示长度, 单位毫米mm)		
		PVC jacket/PVC外被	PUR jacket/PUR外被	
4pins/4针	D code/D型	-10°C~+80°C	-40°C~+105°C	-40°C~+105°C
		12L00966-X	12L00967-X	12L00968-X

Pin assignment front view/针位分布前视图

D code 4pins
D型4针



General data/常规数据

Pins Numbers/针数	4pins/4针
Rated voltage/额定电压	250V
Rated current(40°C)/额定电流	4A
Standards/标准	IEC 61076-2-101
Termination/焊接方式	solder and over-mold/焊接和成型
Degree of protection/防护等级	IP67, IP68, IP69K
Wire gauge(mm²)/线规(平方数)	0.14mm²-0.75mm²
Wire gauge(AWG)/线号(平方数)	26AWG-18AWG
Mechanical operation/插拔次数	>100 mating cycles/大于100次
Contact resistance/接触电阻	≤5mΩ
Insulation resistance/绝缘电阻	≥100MΩ
Connector body/胶芯	TPU
Pins/端子	Brass with gold plated/黄铜镀金
Screw/螺丝	Brass with nickel plated/黄铜镀镍
Environmental compliance/环境符合标准	RoHs, Reach

M12 D code male to male straight molded cable, shielded/M12, D型公头直头对公头直头连接线, 带屏蔽

Illustration/尺寸

Product photo/产品图

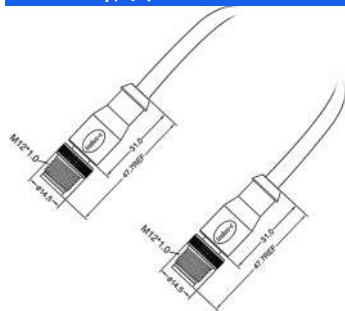

Part number/产品料号

Pins/针数	Code/型	Part number("X" is length millimetre mm)/产品料号("X"表示长度, 单位毫米mm)		
		PVC jacket/PVC外被	PUR jacket/PUR外被	
4pins/4针	D code/D型	-10°C~+80°C	-40°C~+105°C	-40°C~+105°C
		12L00972-X	12L00973-X	12L00974-X

Pin assignment front view/针位分布前视图

D code 4pins
D型4针



General data/常规数据

Pins Numbers/针数	4pins/4针
Rated voltage/额定电压	250V
Rated current(40°C)/额定电流	4A
Standards/标准	IEC 61076-2-101
Termination/焊接方式	solder and over-mold/焊接和成型
Degree of protection/防护等级	IP67, IP68, IP69K
Wire gauge(mm²)/线规(平方数)	0.14mm²-0.75mm²
Wire gauge(AWG)/线号(平方数)	26AWG-18AWG
Mechanical operation/插拔次数	>100 mating cycles/大于100次
Contact resistance/接触电阻	≤5mΩ
Insulation resistance/绝缘电阻	≥100MΩ
Connector body/胶芯	TPU
Pins/端子	Brass with gold plated/黄铜镀金
Screw/螺丝	Brass with nickel plated/黄铜镀镍
Environmental compliance/环境符合标准	RoHs, Reach

M12 D code male straight to female right angle molded cable, shielded/M12, D型公头直头对母头弯头连接线, 带屏蔽

Illustration/尺寸

Product photo/产品图

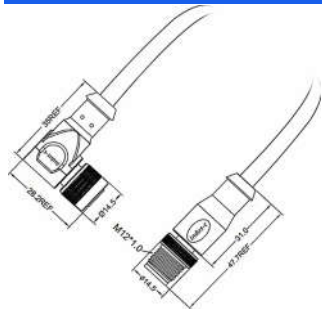

Part number/产品料号

Pins/针数	Code/型	Part number("X" is length millimetre mm)/产品料号("X"表示长度, 单位毫米mm)		
		PVC jacket/PVC外被	PUR jacket/PUR外被	
4pins/4针	D code/D型	-10°C~+80°C	-40°C~+105°C	-40°C~+105°C
		12L00978-X	12L00979-X	12L00980-X

Pin assignment front view/针位分布前视图

D code 4pins

D型4针



D型4针

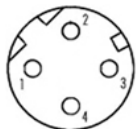

General data/常规数据

Pins Numbers/针数	4pins/4针
Rated voltage/额定电压	250V
Rated current(40°C)/额定电流	4A
Standards/标准	IEC 61076-2-101
Termination/焊接方式	solder and over-mold/焊接和成型
Degree of protection/防护等级	IP67, IP68, IP69K
Wire gauge(mm²)/线规(平方数)	0.14mm²-0.75mm²
Wire gauge(AWG)/线号(平方数)	26AWG-18AWG
Mechanical operation/插拔次数	>100 mating cycles/大于100次
Contact resistance/接触电阻	≤5mΩ
Insulation resistance/绝缘电阻	≥100MΩ
Connector body/胶芯	TPU
Male pin/公端子	Brass with gold plated/黄铜镀金
Female pin/母端子	Phosphorus copper with gold plated/磷铜镀金
Screw/螺丝	Brass with nickel plated/黄铜镀镍
Over-mold/成型	TPU
Environmental compliance/环境符合标准	RoHs, Reach

M12 D code male to female straight molded cable, shielded/M12, D型公头直头对母头直头连接线, 带屏蔽

Illustration/尺寸

Product photo/产品图

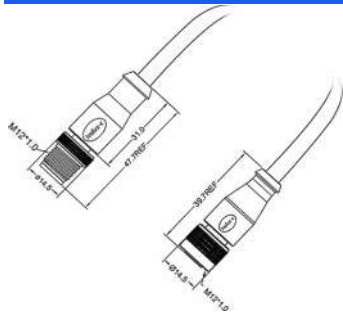

Part number/产品料号

Pins/针数	Code/型	Part number("X" is length millimetre mm)/产品料号("X"表示长度, 单位毫米mm)		
		PVC jacket/PVC外被	PUR jacket/PUR外被	
4pins/4针	D code/D型	-10°C~+80°C	-40°C~+105°C	-40°C~+105°C
		12L00376-X	12L00983-X	12L00984-X

Pin assignment front view/针位分布前视图

D code 4pins
D型4针



D型4针

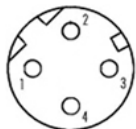

General data/常规数据

Pins Numbers/针数	4pins/4针
Rated voltage/额定电压	250V
Rated current(40°C)/额定电流	4A
Standards/标准	IEC 61076-2-101
Termination/焊接方式	solder and over-mold/焊接和成型
Degree of protection/防护等级	IP67, IP68, IP69K
Wire gauge(mm²)/线规(平方数)	0.14mm²-0.75mm²
Wire gauge(AWG)/线号(平方数)	26AWG-18AWG
Mechanical operation/插拔次数	>100 mating cycles/大于100次
Contact resistance/接触电阻	≤5mΩ
Insulation resistance/绝缘电阻	≥100MΩ
Connector body/胶芯	TPU
Male pin/公端子	Brass with gold plated/黄铜镀金
Female pin/母端子	Phosphorus copper with gold plated/磷铜镀金
Screw/螺丝	Brass with nickel plated/黄铜镀镍
Over-mold/成型	TPU
Environmental compliance/环境符合标准	RoHs, Reach

M12 D code female to female right angle molded cable, shielded/M12, D型母头弯头对母头弯头连接线, 带屏蔽

Illustration/尺寸

Product photo/产品图

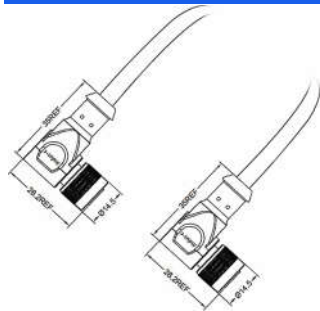

Part number/产品料号

Pins/孔数	Code/型	Part number("X" is length millimetre mm)/产品料号("X"表示长度, 单位毫米mm)		
		PVC jacket/PVC外被	PUR jacket/PUR外被	
4pins/4孔	D code/D型	-10°C~+80°C	-40°C~+105°C	-40°C~+105°C
		12L00988-X	12L00989-X	12L00990-X

Pin assignment front view/孔位分布前视图

D code 4pins
D型4孔

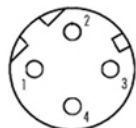

General data/常规数据

Pins Numbers/孔数	4pins/4孔
Rated voltage/额定电压	250V
Rated current(40°C)/额定电流	4A
Standards/标准	IEC 61076-2-101
Termination/焊接方式	solder and over-mold/焊接和成型
Degree of protection/防护等级	IP67, IP68, IP69K
Wire gauge(mm²)/线规(平方数)	0.14mm²-0.75mm²
Wire gauge(AWG)/线号(平方数)	26AWG-18AWG
Mechanical operation/插拔次数	>100 mating cycles/大于100次
Contact resistance/接触电阻	≤5mΩ
Insulation resistance/绝缘电阻	≥100MΩ
Connector body/胶芯	TPU
Pins/端子	Phosphorus copper with gold plated/磷铜镀金
Screw/螺丝	Brass with nickel plated/黄铜镀镍
Environmental compliance/环境符合标准	RoHs, Reach

M12 D code female straight to female right angle molded cable, shielded/M12, D型母头直头对母头弯头连接线, 带屏蔽

Illustration/尺寸

Product photo/产品图

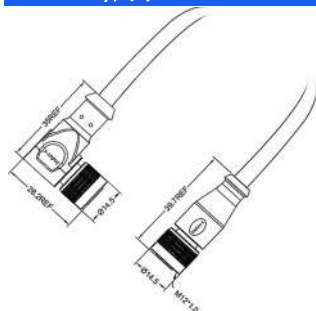

Part number/产品料号

Pins/孔数	Code/型	Part number("X" is length millimetre mm)/产品料号("X"表示长度, 单位毫米mm)		
		PVC jacket/PVC外被	PUR jacket/PUR外被	
4pins/4孔	D code/D型	-10°C~+80°C	-40°C~+105°C	-40°C~+105°C
		12L00994-X	12L00995-X	12L00996-X

Pin assignment front view/孔位分布前视图

D code 4pins
D型4孔

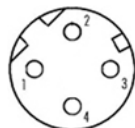

General data/常规数据

Pins Numbers/孔数	4pins/4孔
Rated voltage/额定电压	250V
Rated current(40°C)/额定电流	4A
Standards/标准	IEC 61076-2-101
Termination/焊接方式	solder and over-mold/焊接和成型
Degree of protection/防护等级	IP67, IP68, IP69K
Wire gauge(mm²)/线规(平方数)	0.14mm²-0.75mm²
Wire gauge(AWG)/线号(平方数)	26AWG-18AWG
Mechanical operation/插拔次数	>100 mating cycles/大于100次
Contact resistance/接触电阻	≤5mΩ
Insulation resistance/绝缘电阻	≥100MΩ
Connector body/胶芯	TPU
Pins/端子	Phosphorus copper with gold plated/磷铜镀金
Screw/螺丝	Brass with nickel plated/黄铜镀镍
Environmental compliance/环境符合标准	RoHs, Reach

M12 D code female to female straight molded cable, shielded/M12,D型母头直头对母头直头连接线, 带屏蔽

Illustration/尺寸

Product photo/产品图

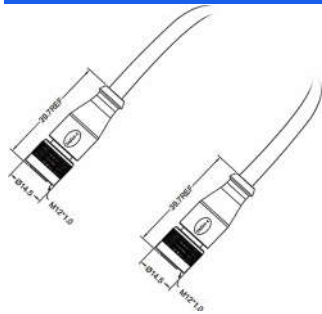

Part number/产品料号

Pins/孔数	Code/型	Part number("X" is length millimetre mm)/产品料号("X"表示长度, 单位毫米mm)		
		PVC jacket/PVC外被	PUR jacket/PUR外被	
4pins/4孔	D code/D型	-10°C~+80°C	-40°C~+105°C	-40°C~+105°C
		12L00999-X	12L01000-X	12L00514-X

Pin assignment front view/孔位分布前视图

D code 4pins
D型4孔

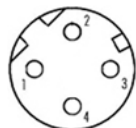

General data/常规数据

Pins Numbers/孔数	4pins/4孔
Rated voltage/额定电压	250V
Rated current(40°C)/额定电流	4A
Standards/标准	IEC 61076-2-101
Termination/焊接方式	solder and over-mold/焊接和成型
Degree of protection/防护等级	IP67, IP68, IP69K
Wire gauge(mm²)/线规(平方数)	0.14mm²-0.75mm²
Wire gauge(AWG)/线号(平方数)	26AWG-18AWG
Mechanical operation/插拔次数	>100 mating cycles/大于100次
Contact resistance/接触电阻	≤5mΩ
Insulation resistance/绝缘电阻	≥100MΩ
Connector body/胶芯	TPU
Pins/端子	Phosphorus copper with gold plated/磷铜镀金
Screw/螺丝	Brass with nickel plated/黄铜镀镍
Environmental compliance/环境符合标准	RoHs, Reach